

# Hi-Touch

Lite / Pro

( VIA / Intel® Platform )

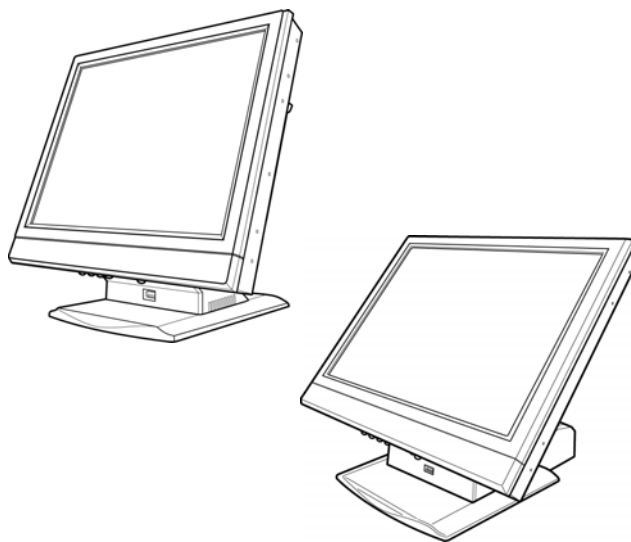

## User's Manual

Version 2.0



## About this Manual

Thank you for purchasing our Hi-Touch Touch Terminal. This terminal offers highly enhanced features, with easy connection to various optional devices for optimum performance. This user manual describes how to set up and connect your terminal.

## Copyright

© Copyright 2008

All rights reserved. This product and related documentation are protected by copyright and are distributed under licenses restricting their use, copying, and distribution. No part of this documentation may be reproduced in any form by any means without prior written authorization of the manufacturer and its licensors, if any.

## Safety notices



### Before You Proceed

- Read the safety notices and the User's Manual carefully before using the product.
- Keep the box and packaging in case the product needs to be shipped in the future.
- Follow the product and warning label instructions.
- Any changes or modifications that do not follow the instructions in this manual will void this product's warranty.



### Power Supply Safety Notes

- To avoid electric shocks, disconnect the power cord from the electrical outlet before relocating the system.
- Make sure the voltage of the power outlet conforms within voltage range of the terminal. Failure to comply may cause the electric shock or damage to the terminal. If you are not sure of the electricity voltage that you are using, contact your local electricity company.
- To avoid fire or electric shocks, do not overload electric power outlets.
- Protect the power cord from being walked on or pinched particularly at plug, convenience receptacles, and the point where they exit from the apparatus.

### Operating Instructions

- Keep this manual for future reference.
- Keep this equipment away from moisture and dust.
- Place the equipment on a stable surface before setting it up.
- If any of the following arises, notify a qualified service technician immediately:
  - The power cord or plug is damaged.
  - Liquid has been spilt on to the equipment.
  - The equipment has been dropped and damaged.
  - The equipment does not function normally.
- Do not block any ventilation openings to prevent the equipment from overheating.
- Do not leave the equipment in a non air-conditioned environment where the storage temperature may go above 70°C (158°F), as this can cause damage to the equipment.

### Maintenance

- Gently wipe screen with a clean soft hair lens brush, or a lint-free cloth.
- Do not apply pressure to the screen while cleaning.
- Do not spray any liquid directly onto the screen or the casing of the Hi-Touch Terminal.
- Chemical cleaners have been reported to cause damage on the screen of the Hi-Touch Terminal.

### Warning and Attention

- The technical descriptions and specifications of the equipment are subject to change without notice.
- For safety reasons, wear gloves when assembling the product.

### Patent

- Patent pending.



### Caution

- Risk of explosion battery is replaced by an incorrect type. Dispose of used batteries according to the instructions.

### Federal Communications (FCC Statement)

This device complies with FCC Rules Part 15. Operation is subject to the following two conditions:

- This device may not cause harmful interference.
- This device must accept any interference received including interference that may cause undesirable operation.

This equipment has been tested and found to comply within the limit of a Class A digital device, pursuant to Part 15 of the FCC Rules. These limits are designed to provide reasonable protection against harmful interference in a residential installation. This equipment generates, uses and can radiate radio frequency energy and, if not installed and used in accordance with the manufacturer's instructions, may cause harmful interference to radio communications. However, there is no guarantee that interference will not occur in a particular installation. If this equipment does cause harmful interference to radio or television reception, which can be determined by switching the equipment on and off, the user is encouraged to try to correct the interference by one or more of the following measures:

- Reorient or relocate the interference receiving antenna.
- Increase the distance of separation between the equipment and interference receiver.
- Connect the equipment to a power outlet on a circuit different from that to which the interference receiver is connected.
- Consult the dealer or an experienced radio/TV technician for help.

|   |  |
|---|--|
|  | <p><b>WARNING:</b></p> <p>The use of shielded cables for connection of the monitor to the graphics card is required to assure compliance with FCC regulations. Changes or modifications to this unit not expressly approved by the party responsible for compliance could void the user's authority to operate this equipment.</p> |
|---|--|

此为 A 级产品，在生活中，该产品可能会造成无线电干扰，在这种情况下，可能需要用户对其干扰采取切实可行的措施。



|   |               |
|---|---------------|
| <b>Chapter 1</b> .....                                  | <b>1</b>      |
| Welcome.....  | 1             |
| Overview of Hi-Touch.....                               | 1             |
| Rear View.....  | 2             |
| OSD Control Buttons.....                                | 3             |
| Features.....   | 4             |
| Unpacking.....  | 5             |
| <br><b>Chapter 2</b> .....                              | <br><b>6</b>  |
| Getting Started.....                                    | 6             |
| Pre-installation Notice.....                            | 6             |
| Default Setting.....                                    | 6             |
| MSR Notice.....   | 7             |
| Rear I/O Jumper Setting (for Pro Model only).....       | 7             |
| Main Board (Intel solution) Jumper Setting.....         | 9             |
| Main Board (VIA solution) Jumper Setting.....           | 9             |
| Limitations.....  | 13            |
| Hardware Installation.....                              | 14            |
| Installing the Adapter and Internet for Lite Model..... | 14            |
| Installing the Adapter and Internet for Pro Model.....  | 15            |
| Installing the Customer Display for Lite Model.....     | 16            |
| Installing the Customer Display for Pro Model.....      | 16            |
| Installing the 2nd display (for Pro Model only).....    | 17            |
| Installing the MSR.....                                 | 18            |
| Easy Maintenance Panel.....                             | 18            |
| <br><b>Appendix</b> .....                               | <br><b>19</b> |
| Technical Information.....                              | 19            |
| Specifications.....                                     | 19            |
| Frequently Asked Questions (FAQ).....                   | 21            |

## Welcome

Congratulations on your purchase of this POS terminal. Your easy-to-use POS terminal is designed to help you enhance your business flexibility by offering a superior customer experience.

### Overview of Hi-Touch

**Lite Model**



**Pro Model**

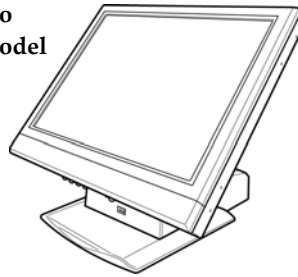

➤ Counter space-saver

➤ Powerful expansion capability  
➤ Dual display for advertising

| Model                     | Hi-Touch (VIA Platform)                           |                              | Hi-Touch (Intel Platform)                                     |                              |
|---------------------------|---|------------------------------|---|------------------------------|
|                           | Lite  | Pro                          | Lite  | Pro                          |
| CPU                       | VIA Eden 1 GHz (Fanless) / VIA C7 2GHz (with Fan) |                              | Intel C-M 1.0GHz 512K Cache (Fanless) / C-M 1.5GHz (With Fan) |                              |
| Chipset                   | VIA CN700 + 8237R+                                |                              | Intel 852GM + ICH4M   |                              |
| System Memory             | 200-pin DDR II RAM *1, up to 1GB (DDR II 400/533) |                              | 200-pin DDR RAM*2, up to 2GB (DDR 200/266)                    |                              |
| HDD                       | 2.5" x 1  | 3.5" x 1                     | 2.5" x 1  | 3.5" x 1                     |
| Storage devices           | CF memory card                                    |                              |   |                              |
|                           | DOM (Disk On Module)                              |                              |   |                              |
| Serial Port               | 3 (Touch & MSR I/F included)                      | 6 (Touch & MSR I/F included) | 3 (Touch & MSR I/F included)                                  | 6 (Touch & MSR I/F included) |
| USB port and Powered USB  | 4 USB 2.0 Ports in total                          |                              |   |                              |
|                           | None  | 2 (1 x 12V/ 1 x 24V)         | None  | 2 (1 x 12V/ 1 x 24V)         |
| DC Output for peripherals | None  | DC 12V & DC 24V plug         | None  | DC 12V & DC 24V plug         |

## Rear View

The rear panel view, with the input and output ports, is shown in the illustration.

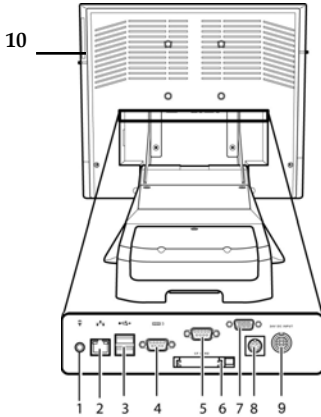

### Upper I/O Ports (Lite/ Pro)

|    | DESCRIPTION                                    |
|----|--|
| 1  | Line Out                                       |
| 2  | LAN port                                       |
| 3  | USB port x 2                                   |
| 4  | COM 3 (Lite only for customer display)         |
| 5  | COM 1 (*1)                                     |
| 6  | CF Card slot                                   |
| 7  | 2 <sup>nd</sup> VGA port (Pro only)            |
| 8  | K/B, M/S Combo port                            |
| 9  | 24V DC input                                   |
| 10 | POS Input Device Port ( 1 x USB + 1 x RS-232 ) |

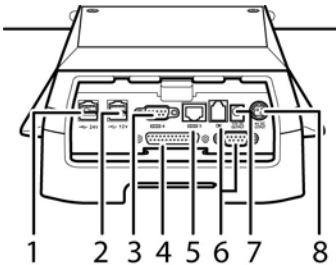

### Lower I/O Ports (Pro only)

|   | DESCRIPTION                                   |
|---|---|
| 1 | Powered USB 24V                               |
| 2 | Powered USB 12V                               |
| 3 | COM 4   |
| 4 | LPT Port                                      |
| 5 | COM 5 (Pro only for customer display)         |
| 6 | COM 6 for Cash Drawer Port (*2)               |
| 7 | 12V DC output for 2 <sup>nd</sup> LCD Display |
| 8 | 24V DC output for POS Printer                 |

\*1 : Only one output between COM1 and RS-232 POS input device port available ( Default : COM1 )

\*2 : Only one output between COM6 and cash drawer port available ( Default : 24V cash drawer port )



OSD Control Buttons

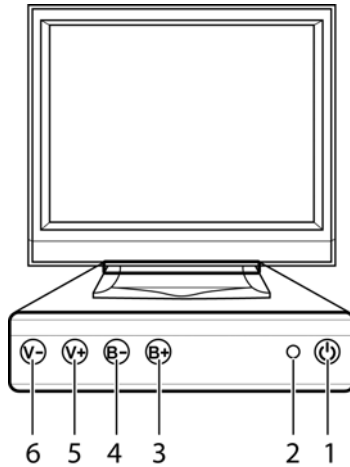

|   | ICON  | FUNCTION   |
|---|---|--|
| 1 |  | Press the Power button to start up the system.<br>Press the Power button for 4 seconds to shut down the system from hardware.<br>Press the Power button and “Brightness +” button for 4-6 seconds to reset the system from the hardware. |
| 2 | Power LED   | Red: Standby mode.<br>Green: System start up.  |
| 3 | B +   | Press “B +” and “B -” button for brightness adjustment. The setting will be saved after releasing the button for 6 seconds.  |
| 4 | B -   |  |
| 5 | V +   | Press “Speaker +” and “Speaker -” button for volume adjustment. The setting will be saved after releasing the button for 6 seconds.  |
| 6 | V -   |  |

**Note:**

Press the “B -” and “V +” at the same time to restore the factory default setting.





### Features

This POS terminal comes equipped with the following features:

- |                                   |   |
|-----------------------------------|---|
| Noise-free                        | <ul style="list-style-type: none"><li>• The fan-less, noise free design of the Hi-Touch is ideal for noise-intolerant environment such as hospitals, museum, and SPA resorts, etc. (Fan-less model only)</li></ul>                            |
| Low power consumption             | <ul style="list-style-type: none"><li>• ULV (Ultra Low Voltage) design of the device is embedded with a unique chip set and CPU renders power saving function.</li></ul>  |
| Saving cost of ownership          | <ul style="list-style-type: none"><li>• Modular design provides the owner with the following benefits: (a) cost effectiveness, (b) customization flexibility, and (c) easy maintenance.</li></ul>   |
| Compact size/<br>Aesthetic design | <ul style="list-style-type: none"><li>• Slimmest in the POS industry standard (24 mm). This elegant, economic POS system features a sleek, compact design base that saves counter space and adds appeal to the service environment.</li></ul> |
| Dust/water-proof                  | <ul style="list-style-type: none"><li>• Hi-Touch series features a highly durable, rigorously tested design that is reliable and dependable in rugged environments.</li></ul>   |
| WEPOS/WinXP Pro solution          | <ul style="list-style-type: none"><li>• Solution is recommended to be bundled with embedded solution for high performance and other added values.</li></ul>   |
| Environment protection            | <ul style="list-style-type: none"><li>• Environmental friendly, RoHS compliant product.</li></ul>   |
| Higher stability                  | <ul style="list-style-type: none"><li>• The Hi-Touch has a longer overall system MTBF and provides higher stability during operation.</li></ul>   |

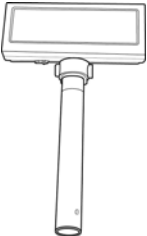
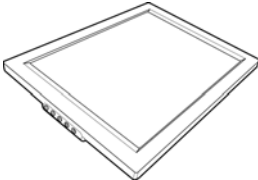
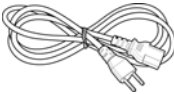
## Unpacking

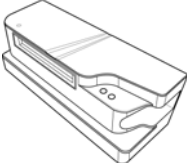
Before setting up your Hi-Touch, check that the package contains the following items. If any of the items is missing or damaged, contact your vendor immediately.

| <b>Hi-Touch Touch Terminal</b>  | <b>Customer Display (optional)</b>   | <b>2nd LCD Customer Display (optional)</b>  |
|---|--|---|
|    |   |  |
| <b>AC Power Cord</b>  | <b>Power Adapter</b>   | <b>Magnetic Stripe Reader (optional)</b>  |
|    |   |  |
| <b>Accessory Package</b>  |  |   |
|  | <ol style="list-style-type: none"><li>1. Driver CD disc</li><li>2. User's Manual</li><li>3. DC24V power cable (Pro only)</li><li>4. PS/2 COMBO Y cable</li><li>5. USB rubber cover</li><li>6. P.E. sheet</li><li>7. Spare screws</li></ol> |   |

## Getting Started

This chapter describes how to install the optional accessories on your Hi-Touch Touch Terminal for optimum serviceability.

### Pre-installation Notice

Before you start installing your Hi-Touch, please read the following notices carefully.

1. The Hi-Touch does not support PCI slot.
2. Do not plug in or unplug any interior devices, such as memory module or any function card, when the ATX PSU is powered on.
3. The LAN chipset of VIA CN700 uses RTL 8139/810x family network adapter. The Terminal has been built-in the PXE Boot ROM function within the BIOS to execute Boot ROM already, but 852GM cannot support Boot ROM function. If you have any questions, please contact your local agent or distributor.
4. For installation and compatibility, using the RAM Module from the original manufacturer is recommended.
5. The USB device connector is Hot Swap capable. Do not plug in or unplug any connector except USB devices when the power is on.
6. The spill proof design of Hi-Touch conforms to IP-43 standard (front panel only).
7. Do not insert or remove any device or component from the Hi-Touch while the power is on.
8. A bug may be found when installing Windows 2000 from a USB CDROM. When this occurs, please go to the Microsoft website at <http://support.microsoft.com/kb/838921> and find the solution.

### Default Setting

#### Default settings for Hi-Touch Touch Terminal serial ports

|       |       |       |        |       |        |
|-------|-------|-------|--------|-------|--------|
| COM1  | COM2  | COM3  | COM4   | COM 5 | COM 6  |
| IRQ 4 | IRQ 3 | IRQ 5 | IRQ 10 | IRQ 5 | IRQ 10 |

## MSR Notice

1. The MSR default setting is ISO Track 1 & 2. (For customized track settings, advise the manufacturer before production.)
2. In event of any requirement to change the setting of the MSR, run Setting utility in the driver CD provided in the accessory package.
3. The normal swiping card speed of the MSR is 10 to 100 cm/sec. (based on the ISO 7812 standard).

### Rear I/O Jumper Setting (for Pro Model only)

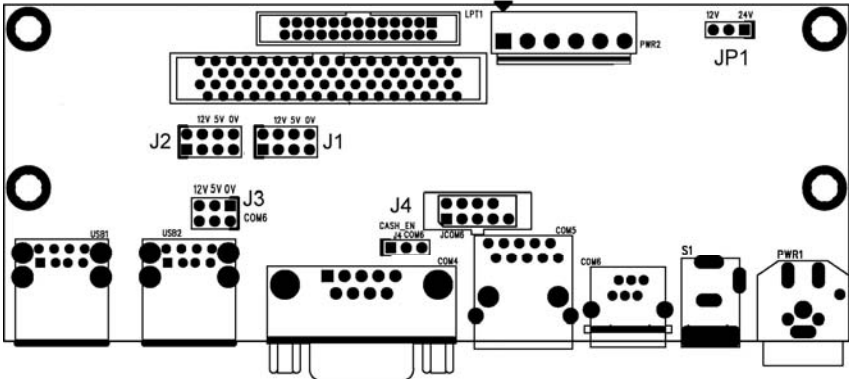

JP1 Cash Drawer 12V/24V Voltage Select

|                |                |
|----------------|----------------|
| Pin 1-2 closed | +24V (default) |
| Pin 2-3 closed | +12V           |

J2 COM4 (D-sub Pin9) Voltage Select

|                |                                      |
|----------------|--------------------------------------|
| Pin 1-2 closed | No Function                          |
| Pin 3-4 closed | +12V                                 |
| Pin 5-6 closed | +5V                                  |
| Pin 7-8 closed | COM Port DC Output Disable (default) |

## Chapter 2 — Getting Started

### J1 COM5 (RJ-45) Voltage Select

|                |                                      |
|----------------|--------------------------------------|
| Pin 1-2 closed | No Function (default)                |
| Pin 3-4 closed | +12V for Customer Display            |
| Pin 5-6 closed | +5V                                  |
| Pin 7-8 closed | COM Port DC Output Disable (default) |

### J3 COM6 (RS-232) Voltage Select

|                |                                      |
|----------------|--------------------------------------|
| Pin 1-2 closed | COM Port DC Output Disable (default) |
| Pin 3-4 closed | +5V                                  |
| Pin 5-6 closed | +12V                                 |

### J4 COM6 RS-232/RJ-11 (Cash Drawer) Select

|                |                                 |
|----------------|---------------------------------|
| Pin 1-2 closed | RJ-11 for Cash Drawer (default) |
| Pin 2-3 closed | RS-232                          |

### RJ-45 8P8C Connector for COM 5 ( Front Side View )

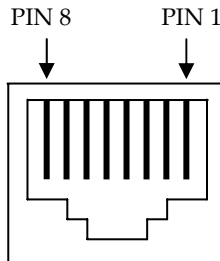

### COM5 ASSIGNMENT

|       |       |     |     |     |     |    |    |
|-------|-------|-----|-----|-----|-----|----|----|
| 8     | 7     | 6   | 5   | 4   | 3   | 2  | 1  |
| V(RI) | V(RI) | GND | GND | DTR | DSR | TX | RX |

**Main Board (Intel Solution) Jumper Setting**

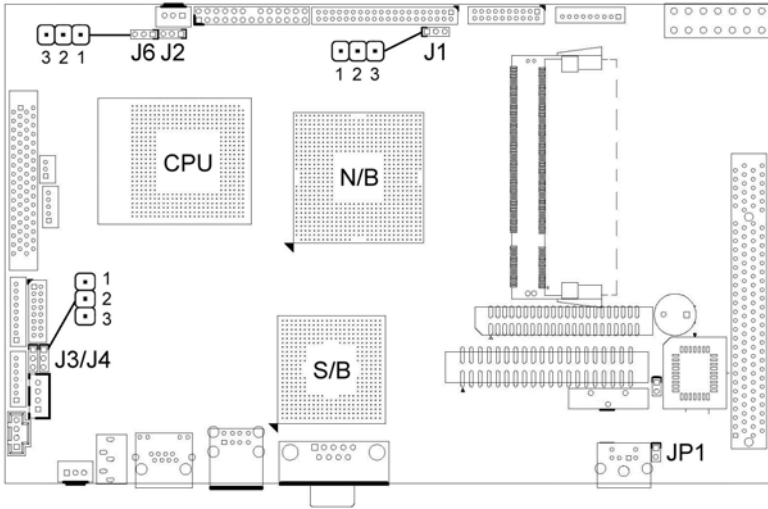

**J3 COM1 (D-sub Pin9) DC Output Select**

|                |                              |
|----------------|------------------------------|
| Pin 1-2 closed | COM Port DC Output Disable   |
| Pin 2-3 closed | +5V or +12V DC Output Enable |

**J4 COM1 (D-sub Pin9) Voltage Select**

|                |      |
|----------------|------|
| Pin 1-2 closed | +5V  |
| Pin 2-3 closed | +12V |

**J6 COM3 (D-sub Pin9) DC Output Select**

|                |                              |
|----------------|------------------------------|
| Pin 1-2 closed | COM Port DC Output Disable   |
| Pin 2-3 closed | +5V or +12V DC Output Enable |

## Chapter 2 — Getting Started

### J2 COM3 (D-sub Pin9) Voltage Select

|                |      |
|----------------|------|
| Pin 1-2 closed | +5V  |
| Pin 2-3 closed | +12V |

### J1 LVDS Voltage Select

|                |       |
|----------------|-------|
| Pin 1-2 closed | +3.3V |
| Pin 2-3 closed | +5V   |

### JP1 CLEAR CMOS

|                |            |
|----------------|------------|
| Pin 1-2 closed | Clear CMOS |
| Pin 1-2 opened | Normal     |



Main Board (VIA Solution) Jumper Setting

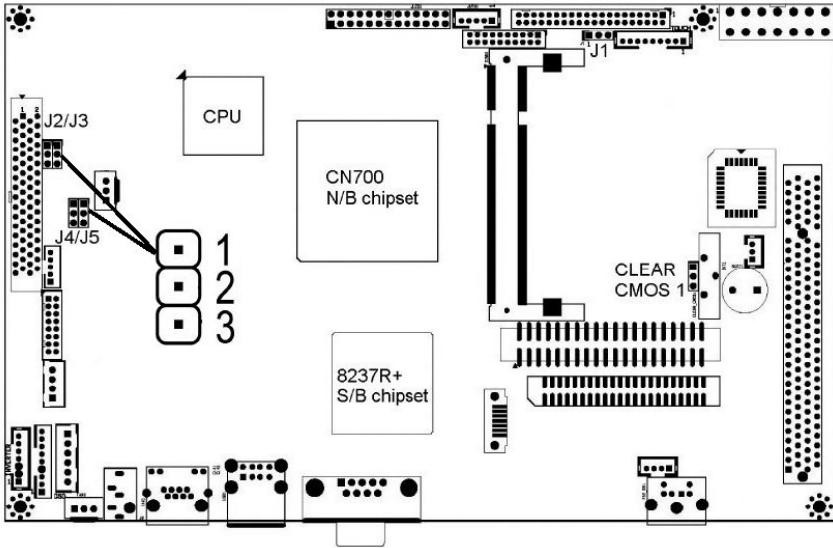

J1 LVDS Voltage Select

|                |                   |
|----------------|-------------------|
| Pin 1-2 closed | +5V               |
| Pin 2-3 closed | +3.3V ( default ) |

J2 COM1 D-sub Pin9 Select (RS-232 MSR)

|                |  |
|----------------|--|
| Pin 1-2 closed | COM Port DC Output Disable ( default ) |
| Pin 2-3 closed | +5V or +12V DC Output Enable           |

J3 COM1 D-sub Pin9 Voltage Select

|                |                 |
|----------------|-----------------|
| Pin 1-2 closed | +5V ( default ) |
| Pin 2-3 closed | +12V            |

## Chapter 2 — Getting Started

### J4 COM3 (D-Sub Pin 9) Select

|                |  |
|----------------|--|
| Pin 1-2 closed | COM Port DC Output Disable ( default ) |
| Pin 2-3 closed | +5V or +12V DC Output Enable           |

### J5 COM3 (D-Sub Pin 9) Voltage Select

|                |                 |
|----------------|-----------------|
| Pin 1-2 closed | +5V ( default ) |
| Pin 2-3 closed | +12V            |

### Clear CMOS 1

|                |                    |
|----------------|--------------------|
| Pin 1-2 closed | Clear CMOS         |
| Pin 2-3 closed | Normal ( default ) |

### Limitations

| Connector with Voltage Output                               | Location                           | Average current                | Pk current                   |
|---|------------------------------------|--------------------------------|------------------------------|
| COM 1 for External input device interface                   | LCD Panel Side                     | DC 5V / 0.5A,<br>DC 12V / 0.5A | DC 5V / 1A,<br>DC 12V / 0.5A |
| COM 2 for Touch Panel interface                             | LCD Panel Side                     | DC 5V / 0.3A                   | DC 5V / 0.5A                 |
| COM 3 for extension interface (9 <sup>th</sup> PIN of DB-9) | LCD Panel Side<br>(On Mother Card) | DC 5V / 0.3A,<br>DC 12V / 0.5A | DC 5V / 0.5A,<br>DC 12V / 1A |
| COM 4 for extension interface (9 <sup>th</sup> PIN of DB-9) | Bottom side (On Interface Board)   | DC 5V / 0.3A,<br>DC 12V / 0.5A | DC 5V / 0.5A,<br>DC 12V / 1A |
| COM 5 for Pole Display (RJ-45)                              | Bottom side (On Interface Board)   | DC 5V / 1A<br>DC 12V / 1A      | DC 5V / 1A,<br>DC 12V / 1A   |
| COM 6 for Cash Drawer driving (Pulse)                       | Internal connector                 | DC 12V / 1A<br>DC 24V / 1A     | DC 12V / 1A,<br>DC 24V / 1A  |
| DC 12V Powered USB for peripherals                          | Bottom side (On Interface Board)   | DC 12V / 1.5A                  | DC 12V / 2.5A                |
| DC 24V Powered USB for peripherals                          | Bottom side (On Interface Board)   | DC 24V / 1.5A                  | DC 24V / 2A                  |
| *2 <sup>nd</sup> LCD Monitor Power Connector (DC Plug)      | Bottom side (On Interface Board)   | DC 12V / 1.5A                  | DC 12V / 2.5A                |
| *DC 24V Printer Power Connector (Hosiden 3PIN)              | Bottom side (On Interface Board)   | DC 24V / 1.5A                  | DC 24V / 2A                  |

---

#### Note:

- The current loading for each COM Port should not exceed DC 5V/3A + DC 12V/2A + DC 24V/2A.
  - DC 12V /24V powered USB should not be used with 12V DC plug and 24V Hosiden at the same time.
  - When the 2nd Display uses 12V DC plug, the thermal printer can **NOT** use the 24V Hosiden simultaneously.
-

### Hardware Installation

#### Installing the Adapter and Internet for Lite Model

To install the adapter and Internet cable for Lite Model, do the following:

1. Connect the Internet cable and the power cable and arrange the cables as shown.

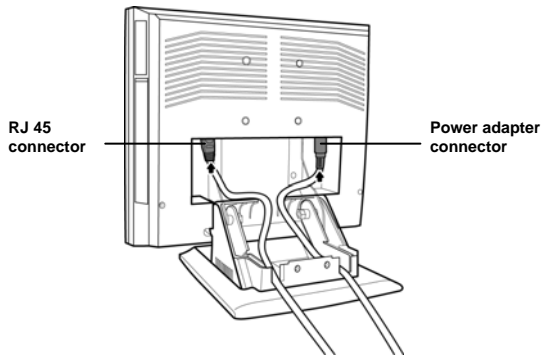

2. Replace the extension base cover and affix it to the base with two M3 back screws.

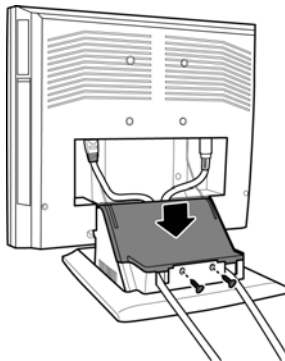

### Installing the Adapter and Internet for Pro Model

To install the adapter and Internet cable for Pro Model, do the following:

1. Connect the Internet cable and the power cable to the connectors and arrange the cables as shown.

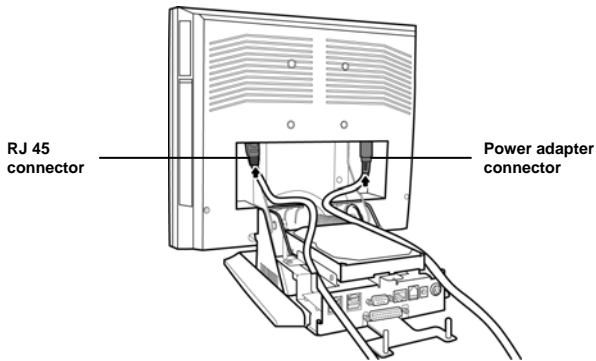

2. Replace the extension base cover with two M3 screws and then affix the stand cover to the base with three M3 screws.

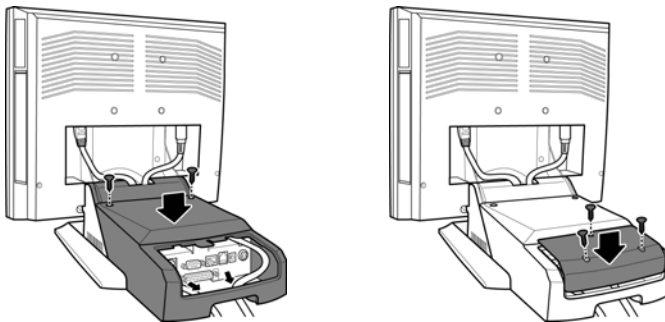

## Chapter 2 — Getting Started

### Installing the Customer Display for Lite Model

Follow the procedures below to install the Customer Display.

1. Connect the VFD DB 9 cable to the connector as shown.
2. Replace the base cover and affix it with two M3 screws.
3. Attach the Customer Display pole bracket to the base of the Hi-Touch Terminal with two M3 screws.
4. Lock the Customer Display to the Customer Display pole bracket with two M3 screws.

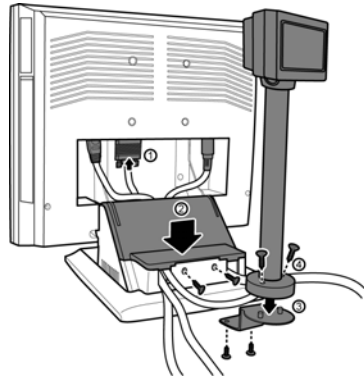

### Installing the Customer Display for Pro Model

Follow the procedures below to install the Customer Display.

1. Plug the VFD RJ-45 connector of the Customer Display into the COM5 port.

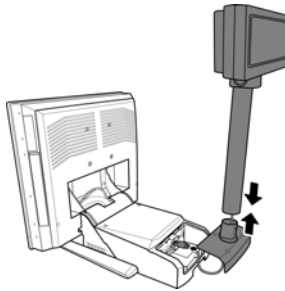

2. Install the Customer Display and the cover stand in place with three M3 screws.

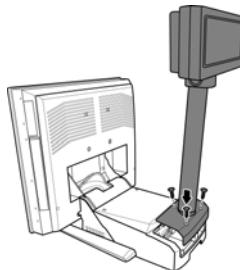

### Installing the 2nd display (for Pro Model only)

To install the 2<sup>nd</sup> display onto the Hi-Touch Terminal, do the following:

1. Connect the DB 15 cable to the connector on the back of the Hi-Touch Terminal LCD screen and arrange the cable as shown.

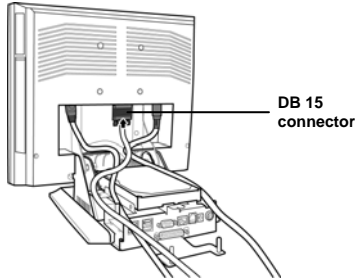

2. Replace the base cover. Connect one end of the DC 12V adapter cable to the base and allow the other end of the cable pass through the hole on the 2<sup>nd</sup> Display cover stand.

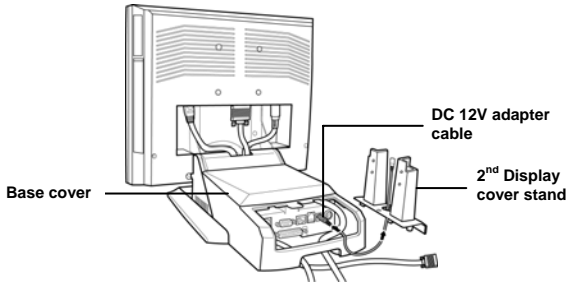

3. Affix the 2<sup>nd</sup> Display cover stand to the base with three M3 screws. Next, connect the other end of the DC 12V adapter cable and the DB 15 cable to the 2<sup>nd</sup> Display.

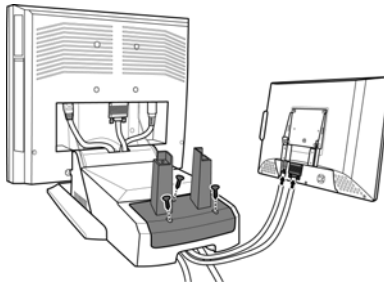

## Chapter 2 — Getting Started

4. Install the 2<sup>nd</sup> Display and lock it to the stand with four M3 screws.

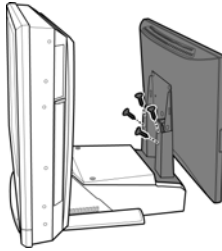

### Installing the MSR

To install the MSR onto the LCD display, do the following:

1. Affix the casing screw to the third screw hole on right side of the LCD display.
2. Connect the MSR USB cable to the connector on the right side of the LCD display.
3. Attach the MSR device onto the screw head on the side of the LCD display and push it downwards to snap into place.
4. Lock the MSR securely on the LCD display with one M3 screw.

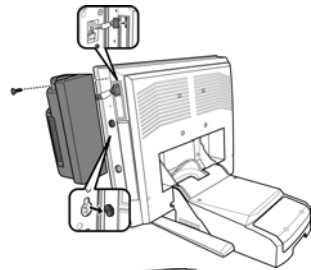

### Easy Maintenance Panel

Open the side panel covers for easy maintenance as shown below. Open the left panel cover to access the LCD Inverter and the right panel cover to access the Touch Controller.

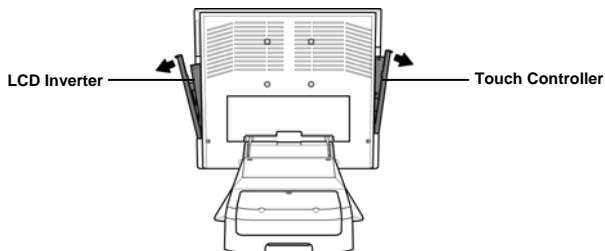



## Technical Information

### Specifications

| ITEM                   | SPECIFICATION  |  |
|------------------------|--|--|
| Model Name             | Hi-Touch All in One Touch POS System   |  |
| Processor              | Supports VIA Eden CPU<br>1.0 GHz / VIA C7 2.0GHz   | Support Intel Celeron-M<br>CPU 1.0GHz 512K Cache/<br>1.5GHz  |
| Memory                 | 200-pin DDR II RAM *1,<br>totality up to 1GB (DDR II<br>400/533)   | 200-pin DDR RAM*2,<br>totality up to 2GB (DDR<br>200/266)  |
| System Core<br>Chipset | North Bridge: VIA CN-700<br>South Bridge: VIA 8237R+   | North Bridge: Intel 852GM<br>South Bridge: Intel ICH4M   |
| BIOS                   | Award BIOS with enhanced ACPI 1.0<br>PnP/APM/DMI/ESCD/PCI bus 2.1/ On Now/ DRAM ECC  |  |
| AGP 3D<br>Graphics     | VIA AGP8X graphics core,<br>share memory from 8MB<br>up to 64 MB (16MB Default)  | Intel AGP8X graphics core,<br>share memory from 8MB<br>up to 32MB (16MB<br>Default), support DVMT to<br>64MB |
|                        | Dual VGA output (Dual-view on North Bridge Chips)<br>Supports 3D/2D graphics accelerator<br>NT 4.0/5.0, Windows 95/98/2000/XP utility<br>APM/ACPI 1.0<br>DirectX 9.0, VPE, MPEG2 |  |
| Parallel Port          | One LPT port (SPP/EPP/ECP), IRQ and address selectable<br>by BIOS setup  |  |
| Serial Port            | Total 6 COM port on board, IRQ selectable by BIOS setup<br>Output on 9th pin by jumper selector. Each voltage output<br>with poly switch protector.                              |  |

## Appendix — Technical Information

| ITEM                             | SPECIFICATION  |  |
|----------------------------------|--|--|
| USB                              | Total 6 USB port (USB 2.0) support<br>One USB port located on the front panel<br>Two USB ports located on the rear panel<br>Two USB ports on extended base (Pro only)<br>One USB port onboard for future use |  |
| Enhance PCI IDE                  | On board PCI bus master IDE1/2, support Ultra DMA33/66/100   |  |
| Serial ATA Port                  | One Serial ATA HDD port  | None   |
| Thermal Solution                 | One heat-sink (Fan-less) or heat-sink with Fan (Base on Fan Speed Control technology) for CPU and North Bridge Chip  |  |
| Compact Flash Card               | One bootable compact flash card socket (Type I/II)   |  |
| Cash Drawer Port                 | One cash drawer port with status sensor. (EPSON ESC Pin define)  |  |
| System Power                     | DC 24V/ 5A /120W external power adapter with internal DC to DC power inverter.   |  |
| AC Power Source                  | AC 90 to 264V Full Range.  |  |
| System Trigger Control           | System front side tact switch (ATX Trigger) below the LCD display with bottom.   |  |
| Ethernet Port (10/100 Mbps Auto) | Realtek RTL8100CL Ethernet chip on board (10/100 base-T)<br>Remote boot ROM in side  | Intel PRO 100 Ethernet chip on board (10/100 base-T) |
|                                  | ACPI/NT 4.0/5.0 (NDIS5)<br>Remote boot ROM for NT 4.0<br>Enable or disable by BIOS setup   |  |
| Audio                            | VIA VT 1612A AC97 CODEC on board   | ACL 203 or 655 AC97 CODEC on board                   |
| Stereo speaker output            | 2 x 1W   |  |
| Keyboard                         | PS/2   |  |
| Mouse                            | PS/2   |  |
| Wall Mount                       | VESA standard 100mm  |  |

| ITEM              | SPECIFICATION   |
|-------------------|---|
| System Size       | 350mm (L) x 350mm (W) x 350mm (H), min. height when folded: 160mm                         |
| S/W Compatibility | DOS/OS2 V2.1/SCO XENIX: V2.3.2/SCO UNIX V3.2/NOVELL/WIN 3.1/95/98/2000/XP/NT4.0/XPE/WEPOS |
| Operation Temp.   | 0°C to 40°C   |
| Storage Temp.     | -25°C to 70°C   |
| Optional Device   | ISO Track 1/2/3 Magnetic Stripe Reader  |
|                   | Smart Card Reader   |
|                   | 20 column * 2 lines VFD Customer Display  |
| Optional Device   | Optical Finger Print Sensor   |
|                   | 10.4" or 12.1" LCD Customer Display   |
|                   | 32 Keys Programmable POS Keyboard   |

**Note:**

Specifications are subject to change without notice.

## Frequently Asked Questions (FAQ)

**Question 1: Why does the system turn to unstable after updating BIOS?**

Answer: Load optimized defaults (or load SETUP Default) after flashing BIOS. If the system remains unstable, clear CMOS to solve the problem.

**Question 2: How do I clear CMOS? (Intel solution)**

Answer: To clear CMOS, do the following:

1. Turn off power and pull out the power cord.
2. Insert the jumper cap to clear CMOS PIN and remove the jumper cap from clear CMOS PIN.
3. Switch on the power again.
4. Press **Delete** to enter CMOS setting and load optimized defaults.
5. Save changes and reboot the system.

**Question 3: How do I clear CMOS (VIA solution)?**

Answer: To clear CMOS, do the following:

1. Turn off power and switch off the power adapter.
2. Remove the jumper from clear CMOS 2-3 PIN and insert the jumper to clear CMOS 1-2 PIN.
3. Remove the jumper from clear CMOS 1-2 PIN and re-insert the jumper to clear CMOS 2-3 PIN.
4. Switch on the power again.
5. Press **Delete** to enter CMOS setting and load optimized defaults.
6. Save changes and reboot the system.

**Question 4: How do I use Boot Menu?**

Answer: To use the Boot Menu, do the following:

1. Press **F9** to enter the Boot Menu.
2. Select the Boot device from the Boot Menu.