

TM-T88III

**User's Manual / Bedienungsanleitung
Gebruikershandleiding / Manuel d'utilisation
Manual do utilizador / Manual del usuario
Manuale dell'utente**

Printer Parts

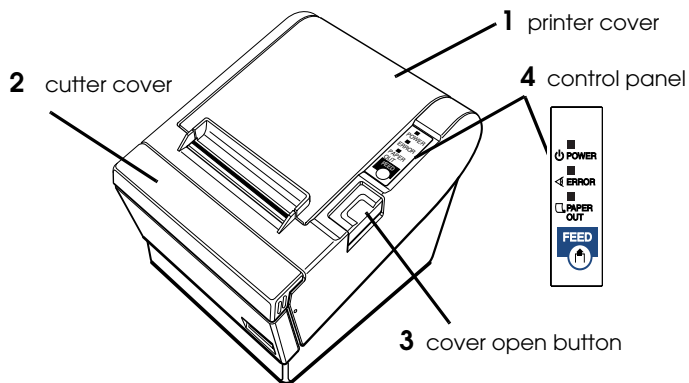

DIP Switch Tables

Serial

SW	Function	ON	OFF
1-1	Data receive error	Ignored	Prints "?"
1-2	Receive buffer capacity	45 bytes	4K bytes
1-3	Handshaking	XON/XOFF	DTR/DSR
1-4	Data word length	7 bits	8 bits
1-5	Parity check	Enabled	Disabled
1-6	Parity selection	Even	Odd
1-7	Transmission speed (See table below.)		
1-8			

Transmission speed (bps)-bits per second	1-7	1-8
38400	ON	ON
4800	OFF	ON
9600	ON	OFF
19200	OFF	OFF

SW	Function	ON	OFF
2-1	Handshaking (BUSY condition)	Receive buffer full	Offline or Receive buffer full
2-2	Do not change		
2-3	Print density/	See Table A	
2-4	Low power		
2-5	Release condition of receive buffer BUSY (If receive buffer capacity set to 4 KB.)	Releases BUSY when remaining receive buffer capacity reaches 138 bytes.	Releases BUSY when remaining receive buffer capacity reaches 256 bytes.
2-6	Do not change		
2-7	I/F pin 6 reset	Enabled	Disabled
2-8	I/F pin 25 reset	Enabled	Disabled

Parallel

SW	Function	ON	OFF
1-1	Auto line feed	Always enabled	Always disabled
1-2	Receive buffer capacity	45 bytes	4K bytes
1-3	Select paper sensors to output paper-end signals (default value of ESC c 3)	Disabled	Paper roll end sensor enabled, Paper roll near-end sensor enabled
1-4-1-8	Undefined		

SW	Function	ON	OFF
2-1	Handshaking (BUSY condition)	Receive buffer full	Offline or Receive buffer full
2-2	Do not change		
2-3	Print density/Low power	See Table A	
2-4			
2-5	Release condition of receive buffer BUSY (If receive buffer capacity set to 4 KB.)	Releases BUSY when remaining receive buffer capacity reaches 138 bytes.	Releases BUSY when remaining receive buffer capacity reaches 256 bytes.
2-6-2-7	Do not change		
2-8	I/F pin 31 reset (Do not change)		

Table A

Print density/low power	SW 2-3	SW 2-4
- Low power consumption mode	ON	ON
1 (Normal)	OFF	OFF
2 (Medium)	ON	OFF
3 (Dark)	OFF	ON

All rights reserved. No part of this publication may be reproduced, stored in a retrieval system, or transmitted in any form or by any means, electronic, mechanical, photocopying, recording, or otherwise, without the prior written permission of Seiko Epson Corporation. No patent liability is assumed with respect to the use of the information contained herein. While every precaution has been taken in the preparation of this book, Seiko Epson Corporation assumes no responsibility for errors or omissions. Neither is any liability assumed for damages resulting from the use of the information contained herein.

Neither Seiko Epson Corporation nor its affiliates shall be liable to the purchaser of this product or third parties for damages, losses, costs, or expenses incurred by purchaser or third parties as a result of: accident, misuse, or abuse of this product or unauthorized modifications, repairs, or alterations to this product, or (excluding the U.S.) failure to strictly comply with Seiko Epson Corporation's operating and maintenance instructions.

Seiko Epson Corporation shall not be liable against any damages or problems arising from the use of any options or any consumable products other than those designated as Original Epson Products or Epson Approved Products by Seiko Epson Corporation.

EPSON and ESC/POS are registered trademarks of Seiko Epson Corporation in the U.S. and other countries.

NOTICE: The contents of this manual are subject to change without notice.

Copyright © 2001 by Seiko Epson Corporation, Nagano, Japan.

EMC and Safety Standards Applied

Product Name: TM-T88III/TM-T88IIP
Model Name: M129C

The following standards are applied only to the printers that are so labeled. (EMC is tested using the EPSON power supplies.)

Europe:	CE marking Safety: EN 60950
North America:	EMI: FCC/ICES-003 Class A Safety: UL 1950/CSA C22.2 No. 950
Japan:	EMC: VCCI Class A
Oceania:	EMC: AS/NZS 3548 Class B

WARNING

The connection of a non-shielded printer interface cable to this printer will invalidate the EMC standards of this device. You are cautioned that changes or modifications not expressly approved by SEIKO EPSON Corporation could void your authority to operate the equipment.

CE Marking

The printer conforms to the following Directives and Norms:

Directive 89/336/EEC	EN 55022 Class B EN 55024 IEC 61000-4-2 IEC 61000-4-3 IEC 61000-4-4 IEC 61000-4-5 IEC 61000-4-6 IEC 61000-4-11
Directive 90/384/EEC	EN 45501

FCC Compliance Statement For American Users

This equipment has been tested and found to comply with the limits for a Class A digital device, pursuant to Part 15 of the FCC Rules. These limits are designed to provide reasonable protection against harmful interference when the equipment is operated in a commercial environment.

This equipment generates, uses, and can radiate radio frequency energy and, if not installed and used in accordance with the instruction manual, may cause harmful interference to radio communications.

Operation of this equipment in a residential area is likely to cause harmful interference, in which case the user will be required to correct the interference at his own expense.

For Canadian Users

This Class A digital apparatus complies with Canadian ICES-003.

Safety Precautions

This section presents important information intended to ensure safe and effective use of this product. Please read this section carefully and store it in an accessible location.



WARNING:

Shut down your equipment immediately if it produces smoke, a strange odor, or unusual noise. Continued use may lead to fire. Immediately unplug the equipment and contact your dealer or a SEIKO EPSON service center for advice.

Never attempt to repair this product yourself. Improper repair work can be dangerous.

Never disassemble or modify this product. Tampering with this product may result in injury or fire.

Be sure to use the specified power source. Connection to an improper power source may cause fire.

Do not allow foreign matter to fall into the equipment. Penetration by foreign objects may lead to fire.

If water or other liquid spills into this equipment, unplug the power cord immediately, and then contact your dealer or a SEIKO EPSON service center for advice. Continued usage may lead to fire.



CAUTION:

Do not connect cables in ways other than those mentioned in this manual. Different connections may cause equipment damage and burning.

Be sure to set this equipment on a firm, stable, horizontal surface. The product may break or cause injury if it falls.

Do not use in locations subject to high humidity or dust levels. Excessive humidity and dust may cause equipment damage or fire.

Do not place heavy objects on top of this product. Never stand or lean on this product. Equipment may fall or collapse, causing breakage and possible injury.

To ensure safety, unplug this product before leaving it unused for an extended period.

Do not use aerosol sprayers containing flammable gas inside or around this product. Doing so may cause fire.

Caution Labels

**WARNING:**

Do not connect a telephone line to the drawer kick-out connector; otherwise, the printer and the telephone line may be damaged.

**CAUTION:**

The thermal head is hot.

**CAUTION:**

Caution label for autocutter blade.

Unpacking

The following items are included with the standard specification printer. If any item is damaged, contact your dealer.

- | | |
|---|--|
| <input type="checkbox"/> Printer | <input type="checkbox"/> Paper roll |
| <input type="checkbox"/> Power switch cover | <input type="checkbox"/> Connector cover * |
| <input type="checkbox"/> AC adapter * | |

* May not be included with your printer.

Downloading Drivers, Utilities, and Manuals

Drivers, utilities, and manuals can be downloaded from one of the following URLs.

For customers in North America, go to the following web site:

<http://www.epsonexpert.com/> and follow the on-screen instructions.

For customers in other countries, go to the following web site:

<http://www.epson-pos.com/>

Select the product name from the "Select any product" pulldown menu.

Installing the Printer Horizontally or Vertically

You can install the printer horizontally on a flat surface (with the paper exit on top) or vertically (with the paper exit at the front) by hanging it on a wall, using the optional WH-10 hanging bracket set.

Control Panel

FEED button

This button feeds paper.

POWER LED

The POWER LED is on when the printer is on.

ERROR LED

This indicates an error.

PAPER OUT LED

On indicates a paper near end or out. Flashing indicates standby.

Using the Power Switch Cover



WARNING:

If an accident occurs with the power switch cover attached, unplug the power cord immediately. Continued use may cause fire or shock.

The enclosed power switch cover ensures that the power switch is not pressed accidentally. To use this cover, install it as shown on the right.

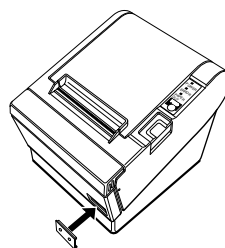

Attaching and Removing the Connector Cover

These instructions apply if a connector cover is packed with your printer to protect your cables. To attach it, follow the steps below:

1. First, connect all the cables. The connector cover has three possible cable exits: on the right, left, and back. Remove the tab for the exit you want to use by breaking it off with your fingers. See the illustration on the right.

Note:

Once you remove a tab, you cannot replace it.

2. After removing the tab, also remove any protruding plastic, so that the edge is smooth and does not damage the cables.
3. Position the two hooks on the connector cover so that they hook the printer case, as shown on the left below.
4. Push the connector cover down to click onto the printer case.

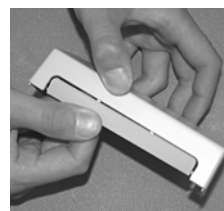

To remove the connector cover, turn the printer over, insert a flathead screwdriver under one hook, and pry up the hook while lifting the connector cover. See the illustration on the right below. Repeat this step for the other side.

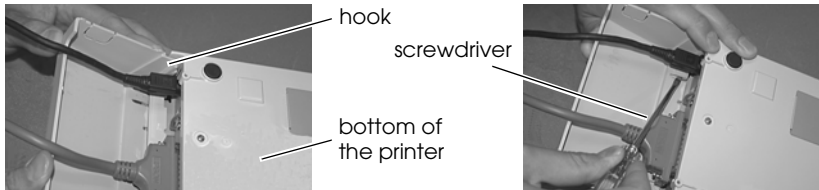

Note:

Be careful not to damage the cables with the screwdriver.

Installing the Paper Roll

1. Press the button, as shown on the left below, to open the cover.
2. Remove any used paper roll core, and insert the paper roll as shown in the center below.
3. The correct direction of the paper is shown on the right below.

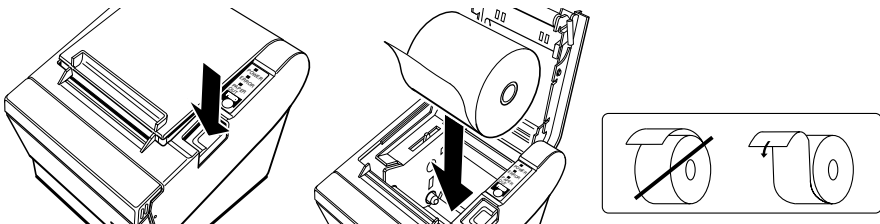

4. Pull out some paper, as shown on the left below, close the cover, and tear off the paper, as shown on the right below.

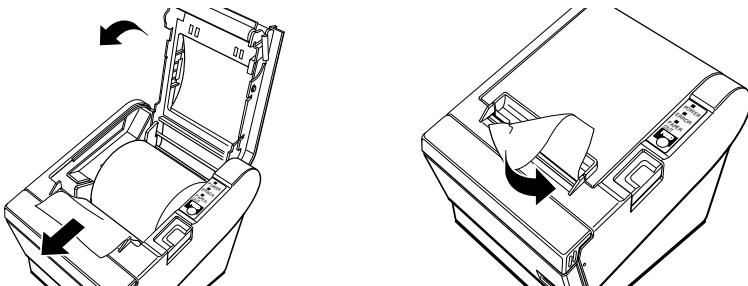

Troubleshooting

No LEDs on the control panel

Check the power supply cable connections and the power outlet.

ERROR LED on (not flashing) with no printing

If PAPER OUT is **on**, the paper roll is not installed or is near the end.
If PAPER OUT is **off**, the printer cover is not closed properly.

ERROR LED flashing with no printing (and no paper jam)

Printing stops if the head overheats and resumes when it cools.
Turn the printer off, and after 10 seconds, back on.

Removing Jammed Paper



CAUTION:

Do not touch the print head because it can be very hot after printing.

1. Turn the printer off and press the cover open button.
2. Remove jammed paper, reinstall the roll, and close the cover.
3. If paper is caught in the cutter and you cannot open the printer cover, open the cutter cover as shown on the left below.
4. Turn the knob until you see a triangle in the opening, as shown on the right below. This returns the cutter blade to the normal position. There is a label near the cutter to assist you.

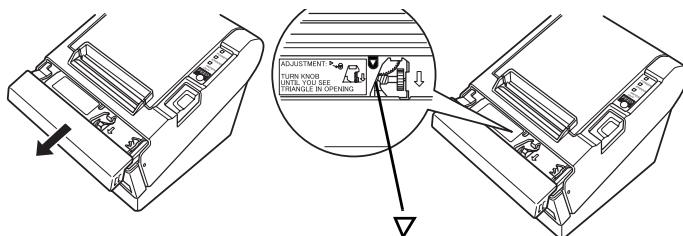

5. Close the cutter cover.
6. Open the printer cover and remove the jammed paper.

Cleaning the Print Head



CAUTION:

After printing, the print head can be very hot. Be careful not to touch it and to let it cool before you clean it. Do not damage the print head by touching it with your fingers or any hard object.

Turn off the printer, open the paper roll cover, and clean the thermal elements of the print head with a cotton swab moistened with an alcohol solvent (ethanol, methanol, or IPA).

EPSON recommends cleaning the thermal head periodically (generally every 3 months) to maintain receipt print quality.

TM-T88III Specifications

Printing method	Thermal line printing
Dot density	180 dpi × 180 dpi (dots per 25.4 mm {1"})
Printing direction	Unidirectional with friction feed
Printing width	80 mm paper width model: 72 mm {2.83"}, 512 dot positions 58 mm paper width model: 50.8 mm {2"}, 360 dot positions
Characters per line (default)	80 mm paper width model: Font A: 42; Font B: 56 58 mm paper width model: Font A: 30; Font B: 40
Character spacing (default)	Font A: 0.28 mm {0.01"} (2 dots); Font B: 0.28 mm {0.01"} (2 dots)
Character size	Standard/Double-height/Double-width/Double-width and Double-height Font A: 1.41 × 3.39 mm/1.41 × 6.77 mm/2.82 × 3.39 mm/2.82 × 6.77 mm Font B: 0.99 × 2.40 mm/0.99 × 4.80 mm/1.98 × 2.40 mm/1.98 × 4.80 mm
Number of characters	Alphanumeric characters: 95; International characters: 37 Extended graphics: 128 × 11 pages (including one space page)
Print speed	High-speed: Approx. 150 mm/s {5.9"/s} max.; 47.2 lps, max. (3.18 mm {1/8"} feed); 35.5 lps, max. (4.23 mm {1/6"} feed, at 24 V, 28°C {82°F}, density level 1). Speed is adjusted automatically depending on the voltage applied and head temperature. Low-power: Approx. 16.5 lps (4.23 mm feed {1/6"}); 70 mm/s {2.76"/s} Ladder bar code: Approx. 42 mm/s (approx. 1.7"/s)
Paper feed speed	Approx. 150 mm/s (approx. 5.9"/s) continuous paper feed
Line spacing (default)	4.23 mm {1/6"}
Character structure	Font A: 12 × 24; Font B: 9 × 17 (including 2-dot horizontal spacing) Font A is the default.
Paper roll (single-ply)	Size: 80 mm paper width model: 79.5 mm ± 0.5 mm {3.13" ± 0.02"}, 58 mm paper width model: 57.5 mm ± 0.5 mm {2.26" ± 0.02"} Maximum outside diameter: 83 mm {3.26"} Paper roll spool diameter: Inside: 12 mm {0.47"}; Outside: 18 mm {0.71"}
Thermal paper type	Specified: Nakagawa Seisakujo, NTP080-80, NTP058-80 (Original: Nippon Paper Industries Co., Ltd., TF50KS-E) Packaged paper roll: original: Oji Paper Mfg. Co., Ltd., PD160R
Interface (compatible)	RS-232C/BI-directional parallel Dealer option: RS-485, USB, 10 Base T I/F

Receive buffer	4KB/45 bytes
DKD Function	2 drives
Power supply	+ 24 VDC \pm 7%
Current consumption (at 24V)	High-speed mode: Mean: Approx. 1.8A Peak: Approximately 7.7A Low-power mode: Mean: Approx. 1.2A Peak: Approximately 6.6A
Life	Mechanism: 15,000,000 lines Thermal head: 100 million pulses, 100 km Autocutter: 1,500,000 cuts
MTBF	360,000 hours
MCBF	52,000,000 lines (Average failure interval based on failures relating to wearout and random failures up to the life of 15 million lines.)
Temperature	Operating: 5 to 45°C {41 to 113°F} Storage: -10 to 50°C {14 to 122°F}, except for paper
Humidity	Operating: 10 to 90% RH Storage: 10 to 90% RH, except for paper
Overall dimensions	148 × 145 × 195 mm {5.83 × 5.71 × 7.68"} (H × W × D)
Weight (mass)	Approximately 1.8 kg {3.96 lb}

lps: lines per second

dpi: dots per 25.4 mm (dots per inch)